



## I. INTRODUCTION

The chassis on which Mustang is based was first introduced for Falcon/Comet in 1960. This basic chassis grew to encompass the Mustang, Cougar, Fairlane, Ranchero, Econoline, Torino, Montego, Maverick, Granada, Monarch, and Versailles, and was retired after the 1980 model year to be replaced by the Fox chassis.

During this time, the suspension remained basically the same with minor modifications made to accommodate changes to track width and wheelbase. Year model changes resulted in three families of V8 steering knuckles (spindles) which had unique geometries. The first was 63-65 Falcon and 65-66 Mustang, the second family starting with 66 Falcon, including drum brake 67-73 Mustang and 74-80 Maverick/Comet and Granada/Monarch. A third disc brake specific type was introduced for year models 68-73. Minor structural design modifications were made in 1970 for all 70-73. CSRP's spindle for the SWAP.3 application encompasses these improvements. The 1970 type drum spindle was used on all drum brake equipped Maverick/Comet. 1974-77 Maverick/Comet and 75-80 Granada/Monarch utilized a disc brake specific spindle that was identical in all but minor respects to the 70-73 Mustang disc brake spindle.

For our purposes, this guide covers the installation of CSRP SWAP.3 five lug front disc brake conversion kit, applicable to all Falcon chassis based cars made during 1960-1980. These include Falcon, Mustang, Cougar, Fairlane, Torino, Maverick, Granada, and the Mercury cousins of these cars. The SWAP.3 kit is an updated reproduction of the disc brakes originally available as an option with 68-73 Mustangs. CSRP produces two sets of steering knuckles (spindle) based on the 1970-73 disc brake specific design. The types differ in that one has steering and suspension geometry that is correct for pre 67 Mustang applications (pre 66 for Falcon, Fairlane), and another that is correct for 67-73 Mustang applications (and equivalent).

### **What does the SWAP involve?**

The SWAP involves replacing everything connected to the ball joints and inner tie rod sleeve, as well as the soft brake hoses, the master cylinder, and installing a proportioning valve. Many installers will also replace suspension components at this time. This discussion is limited to the disc brake SWAP itself. The SWAP will require a set of serviceable basic tools. A tie rod separator or a 3 lb. hammer, and a floor jack make the job easier.

## II. DISASSEMBLY

1. Jack the front of the car off the ground and place jack stands on a chassis hard point just to the rear of the front wheels. Perform steps 2-11 on one wheel at a time.
2. Remove the wheel.
3. Have a jar or basin ready. Cut the brake hose near the wheel cylinder. Direct the flow of brake fluid to the container.
4. Turn the steering wheel as to maximize access to the steering knuckle area.
5. Place a jack under the lower control arm and raise it to compress the spring a bit.
6. Remove the sway bar and strut rod bolts.
7. Remove the cotter pins on the ball joints and the outer tie rod. This may prove difficult. Carefully straighten the pins and pull them out with pliers. If they break off, you may be able to drive them out with a nail.
8. Loosen but don't remove the ball joint and tie rod bolts.
9. Loosening the tie rod and ball joint studs from their tapered mount holes requires technique. There are three main accepted methods. You can use a suspension fork to separate the studs from their mount, but you will invariably do damage to the rubber boots and or tie rod. You could use a ball joint separator tool (these are like a bearing puller and can be rented or loaned from auto parts stores). An alternate method is to pound the end of the mounting bosses that the mount holes are bored into, with a 3 lb. hammer. One has to really whale on the boss. It is hard to get the required angle and clearance to hit it hard enough unless the car is on a rack. Persistence is required. Don't worry about breaking the knuckle, it's tough. The stud will eventually be shocked loose from the knuckle.
10. Break the tie rod loose first, then the ball joints.
11. Manipulate the knuckle/brake assembly from the suspension.
12. Separate the old hose from the hard line. It's best to use a flare wrench when tightening or loosening brake fittings. It helps to apply penetrating oil or heat prior to the attempt to remove flare fittings.
13. Evaluate if the tubes are serviceable. Replace or repair any corroded or crimped tubes, or any bad fittings.
14. Remove the one or two hard lines from the master cylinder. A flare wrench makes the job much neater. You may find that the fittings will not come off or that the nut becomes stripped. In this case clamp a vise-grip onto the fitting snugly and strike it with a hammer in order to break the threads loose. It is possible that you will destroy the fitting or tube. The most important tube is the rear brake lead, the next important are the front leads.
15. Remove the two bolts that connect the master cylinder to the firewall.
16. Try to pull the master cylinder straight out from the firewall. Sometimes the master cylinder push rod is mechanically retained in the master cylinder. If so, you will be required to wedge yourself under the dash and disconnect

the push rod from the brake pedal. Remove the master cylinder. Be careful not to spill brake fluid on the paint. Immediately remove any spills from the paintwork.

### III. ASSEMBLY *(For purposes of clarity, the images depict the assembly on a bench, not on the car)*

#### A. Mounting the knuckle

1. Reassembly requires attention to detail. Use a decent torque wrench to make final tightening. Work methodically.
2. Mount the caliper bracket to the knuckle. Use the high strength thread locker included in the kit on the threads. Don't overdo the thread locker.
3. Alternate the tightening of the bolts until they reach their ultimate torque of 55-75 ft-lb for the 7/16" bolt and 90-120 ft-lb for the 1/2" bolt.



4. Lightly lube the ball joint and tie rod mount holes with grease.
5. Mount the lower ball joint boss of the knuckle to the lower ball joint and thread the nut on a few threads. Raise or lower the knuckle/lower control arm until you can get the upper ball joint stud in its mount and screw on its' nut.
6. Torque the ball joint nuts such that the hole in the ball joint stud lines up to one of the nut's castleations at a torque between 75-95 ft-lb.
7. Insert the supplied cotter pin and bend to secure.
8. Reconnect the strut rod and sway bar mounts to the lower control arm. Torque the strut rod to 90-115 ft-lb and the sway bar mounts to 6-12 ft-lb.
9. Install the caliper guide pin's rubber isolators (see image below).
10. Install the inner brake pad and pad retainers (see image below).



## B. Mounting tie rod ends

1. Loosen the nut on the end of the adjusting sleeve for the outer tie rod end.
2. Measure and record the distance from the end of the sleeve, where the tie rod end threads go in, to the center point of the tie rod mounting stud.
3. Remove the old tie rod end.
4. Thread the new tie rod into the sleeve. Note that some applications have driver and passenger side specific outer tie rods.
5. Adjust the depth that the tie rod is threaded such that the distance from the sleeve to center point of the stud matches the original.
6. Lightly grease the tie rod ball stud and mount with grease.
7. Center the steering wheel.
8. Fit the tie rod stud into the mount on the steering arm.
9. Torque the tie rod stud nuts such that the hole in the stud lines up to one of the nut's castellations at a torque between 35-47 ft-lb.
10. Insert the supplied cotter pin and bend to secure.

## C. Mounting the splash shield

1. Place one of the foam gaskets supplied in the dust shield kit onto the spindle and against the shield mounting surface. (See the photo below).



2. Identify the correct shield. The cut out on the shield will frame the caliper bracket. Mount the shield.



3. Place the triangular mounting flange over the shield.
4. Apply a small amount of the medium strength thread locker supplied with the kit to the shield mounting bolts.
5. Orient the mounting flange such that the triangle corner with a circular piece cut out on its corner is positioned in the upmost position.
6. Thread the bolts and torque to 9-12 ft-lb.

#### D. Assembly of the under fender brake components

1. Remove the rotors from their packaging. Regardless of package markings, the preferred orientation for the rotor slots for the outboard sides is to radiate from the hub to the edge in a clockwise fashion for the passenger side, and anti-clockwise for the driver side.
2. Pack the wheel bearings with high temp disc brake service type wheel bearing grease (GCLB grade type NLGI 2 specification). This author makes a mess of himself and my surroundings every time I pack bearings. The least messy method I know of is to put a bearing in a baggie along with a moderate quantity of grease and knead the grease into the bearing for a few minutes. Repeat with all four bearings. Make sure to add some more grease to the baggie after each bearing.

3. Stage the bearings on a clean piece of paper until they are used.
4. Inspect the interior of the hub for excessive casting flash (unwanted metal), and casting sand. Use a wire brush and compressed gas to remove any sand present (not common). Remove any flash that would interfere with the pin (very uncommon).
5. Prepare the rotor. Apply a thick layer of the disc brake wheel bearing grease to the inside of the rotor hub and the bearing races. Careful, there may be sharp casting flash inside the hub.
6. Insert the inside (larger bearing) into the inside of the rotor hub such that it seats onto its race. See the photo below.



7. Place a wheel grease seal onto its recess on the inside of the hub. Carefully tap the edge of the seal until it becomes secured into place. Tap around the seal to insure it is completely seated. See the photo below.
8. Apply a scant amount of grease to the wheel seal's sealing surface on the spindle.
9. Carefully insert the rotor onto the spindle. Don't scrape the seal over the threads on the end of the spindle. You should be able to feel the seal slip over the sealing surface on the spindle. You may need to wobble the rotor a bit to seat the inner bearing onto its place on the stub axle.
10. Carefully insert the rotor onto the spindle. Don't scrape the seal over the threads on the end of the spindle. You should be able to feel the seal slip over the sealing surface on the spindle. You may need to wobble the rotor a bit to seat the inner bearing onto its place on the stub axle.





11. Carefully insert the rotor onto the spindle. Don't scrape the seal over the threads on the end of the spindle. You should be able to feel the seal slip over the sealing surface on the spindle. You may need to wobble the rotor a bit to seat the inner bearing onto its place on the stub axle.
12. Insert the outer (smaller) wheel bearing onto the spindle until it seats upon the hub race. The smaller ends of the two tapered bearings should be facing each other.
13. Fit the bearing retainer (large washer) onto the spindle with its tab seated in the keyway on the stub axle.
14. Fit the wheel nut onto the spindle. Hand tighten the nut.
15. Using a properly calibrated torque wrench, torque the wheel nut, while spinning the rotor, to 17-25 ft-lb. Spin the rotor several revolutions. The wheel bearings are now pre-loaded and subsequent retightening will torque accurately.
16. Back off the wheel nut a half turn.
17. Retighten the nut such that it torques to 10-15 ft-lb with the nut oriented such that the cotter pin can fit through both the hole in the spindle and through a castellation on the retainer. Fit the castellated retainer over the nut. Fit a cotter pin through the axle and bend to secure.
18. Wash your hands, wipe everything with a clean cloth, and clean the rotor with brake cleaner.



19. Select the caliper to mount. The part number for the right side is 4012 and the left is 4013. This is probably meaningless to you since you have most likely already removed the calipers from their boxes to admire them, and now have no idea which box they belong in. The caliper that results in the bleeder being in the forward higher position is the correct one. Note the position of the bleeder screws in the photo.



20. Install the outboard brake pads onto their caliper using the pins and clips shown in the series of images below. Support the pin going through the pad and caliper body from the inside so that it does not retreat when the clip is applied. The clip is compressed over the pin such that the slot cut in it fits into the groove at the end of the pin. Be careful with the clip, it is made from brittle spring steel.



21. Mount the caliper assembly over the rotor. It may appear that the rotor will not fit between the pads, but it will, it just requires a bit of finessing.
22. Secure the caliper assembly to the caliper bracket along with the Galvanized caliper shield using 2 each caliper guide pins and 2 each 5/16"-18 X1/2" serrated head bolts. Use medium strength thread locker on the serrated head bolts threads. See the image above.
23. Fit a copper washer at the top and bottom of the brake hoses banjo fitting. Fit a banjo bolt. The order of assembly is banjo bolt, washer, banjo fitting, washer, and finally the caliper.
24. See the images below to identify the correct brake hose for each side, and their proper orientation on the caliper and at the mount point on the frame rail. The position is centered under the upper control arm and may have the mounting holes present from the factory. The images showing the hose mounted to the frame rail depict the left side hose. The left side of those images is the front side of the car.
25. Do not use thread locker or thread sealant on the hose fittings or banjo bolt. They may be lightly greased. Tighten them snugly.

26. Note that the terminal end of the original “drum” brake lines incorrectly addresses the inlet end of the disc brake hoses. It will be necessary to re-bent them or cut off and refitted the tube nuts as shown in the image.





#### E. Assembly of the under hood components

1. To bench bleed the master cylinder;
2. Secure the master.
3. Remove the master cylinder cap. Fill the reservoir with brake fluid.  
Remove the caps from the master cylinder outlets. There are 2 approved methods for bleeding the master cylinder.
4. **1<sup>ST</sup> METHOD:** Fit the 2 metal bench bleeding tubes to their outlets with the other end led into the respective reservoir. Actuate the master cylinder's piston using a dowel or blunt rod. The piston is stroked slowly, avoiding applying too much pressure at the end of the stroke. Release the piston; it will retract on its own. Note the air being expelled from the tube followed by a solid stream of fluid. Continue until both bleeding tubes expel a solid stream. Remove the bleeding tubes and recap the outlets.

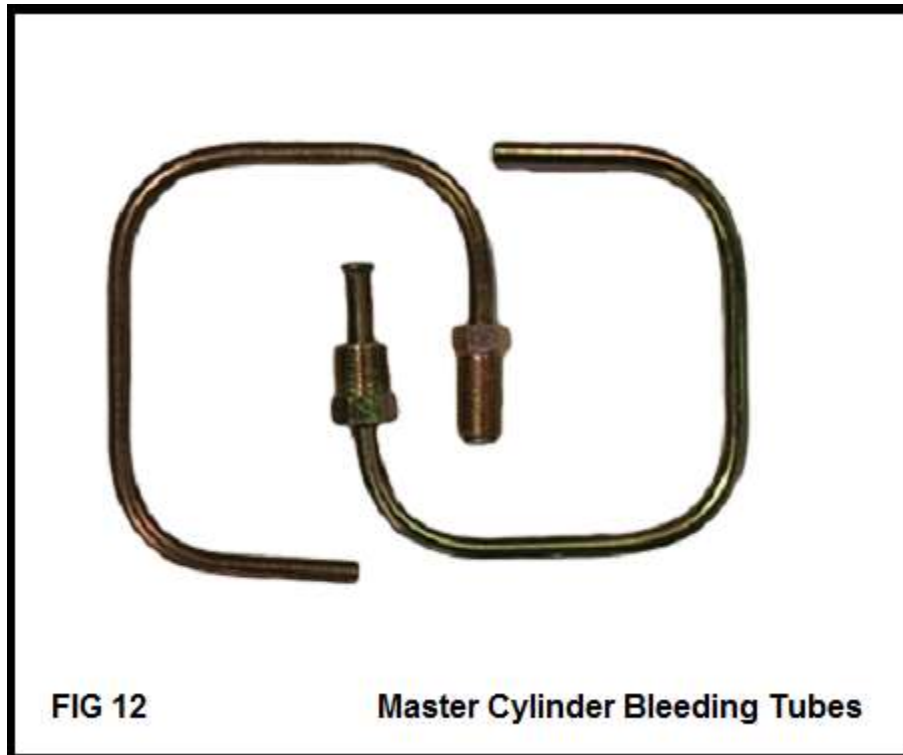
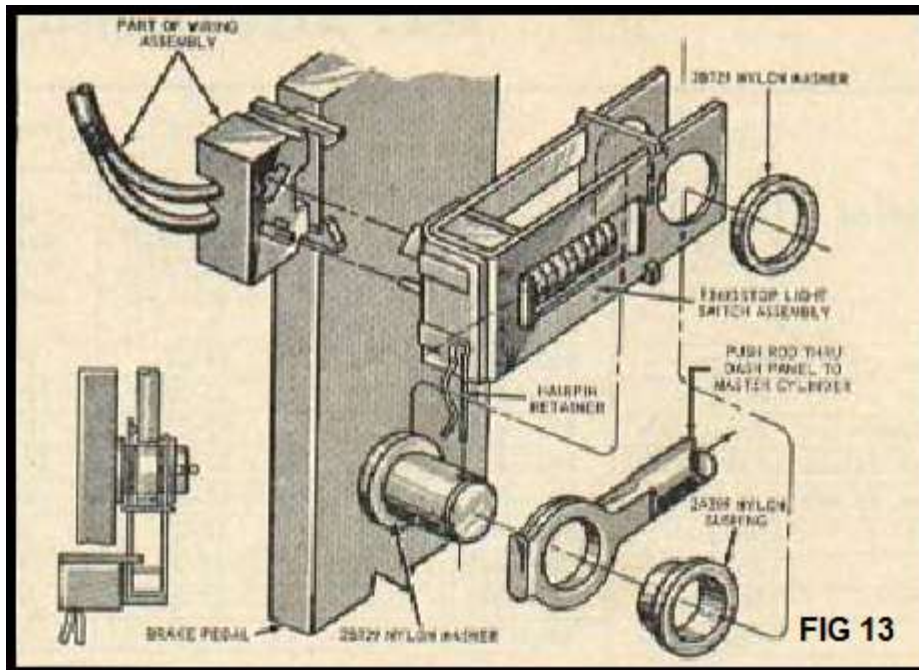
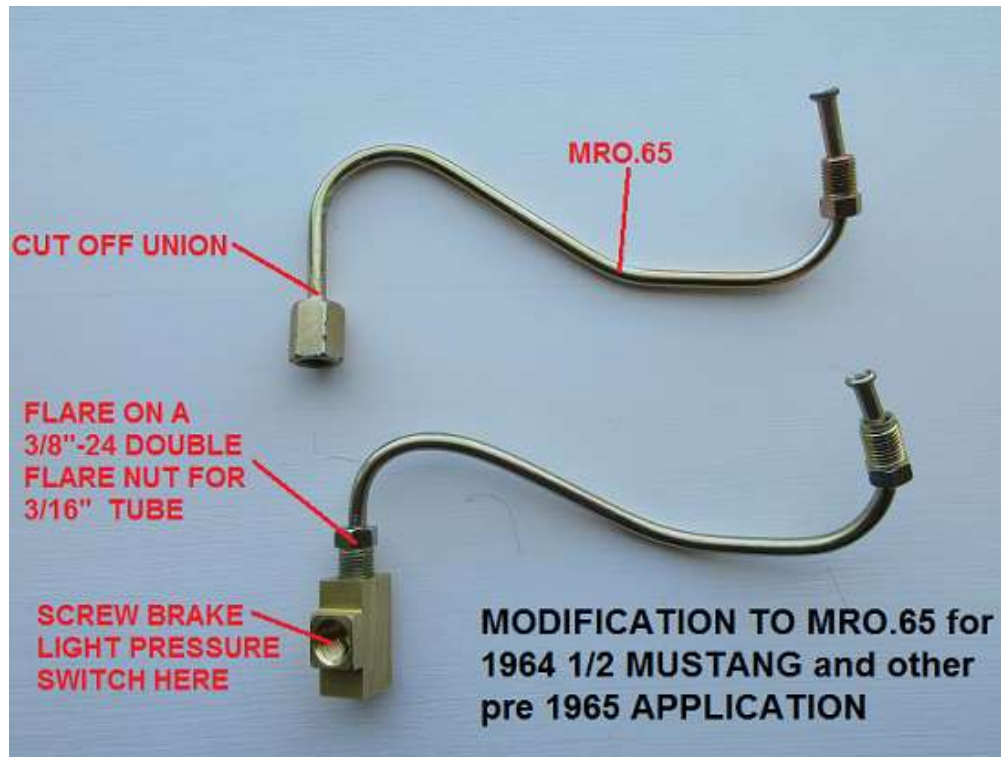

FIG 12

Master Cylinder Bleeding Tubes

5. **2nd METHOD:** If plugs (full pressure plugs, not just caps) are available, apply them to the outlets of the master cylinder. Actuate the master cylinder's piston using a dowel or blunt rod. The piston is stroked slowly, avoiding applying too much pressure at the end of the stroke. Release the piston; it will retract on its own. Air will be expelled from the bypass orifices in the master cylinder's reservoirs. The piston will be increasingly difficult to depress, eventually becoming so solid that it cannot be depressed.
6. Install the adjustable push rod supplied with the kit. Note that the push rod has a clip at its end that will firmly retain it in the master cylinder (it cannot be removed without damaging the rod and/or master cylinder).
7. Assemble the adjustable proportioning valve on its bracket. Since the valve is symmetrical, the knob can be oriented to point toward the inner fender or toward the engine.
8. Mount the master cylinder to the firewall along with the adjustable proportioning valve and bracket. Note that the bracket is secured between the forward side of the master cylinder and the bolts that mount the master cylinder to the firewall. The assembly order is firewall, master cylinder, bracket, bolts.





9. Prior to its final installation onto the brake pedal peg, the adjustable push rod's length can be shortened or lengthened to adjust the brake pedal height. Make sure that the limiting arm at the top of the brake pedal does not touch the brake pedal hanger/bracket when the pedal is at rest.
10. Reconnect the eyelet end of the master cylinder push rod onto the peg on the brake pedal, incorporating the existing brake light switch (the brake light switch on a "64 1/2" Mustang or pre 65 Falcon/Comet will be actuated by a pressure sensor, not a switch at the pedal). Plumb the 64 1/2 type pressure switch inline using TEE fitting connected in place of the female union fitting on the MRO.65 brake line. CSRP can supply the adapted pieces for a small charge.
11. Connect the LKM.65 line kit as shown in the year appropriate picture. The images depict the installation of the under hood brake line kit components
12. Do not over tighten the fittings since the fitting seats can be damaged. The fittings require only 1/8 to 1/4 turn tightening past the point where the tube flare contacts the seat (past hand tight).
13. Be sure to install the 3/8" flare plug in the distribution block outlet that previously received the brake line coming from the rear brakes.
14. The flare nut at the end of the brake line coming from the rear brakes will now be fitted to the female fitting on the end of the line leading from the outlet of the proportioning valve. **Be sure** to support the female hex fitting with an appropriate wrench when tightening the nut (**failure to do so will damage the fittings connection to the tube**).



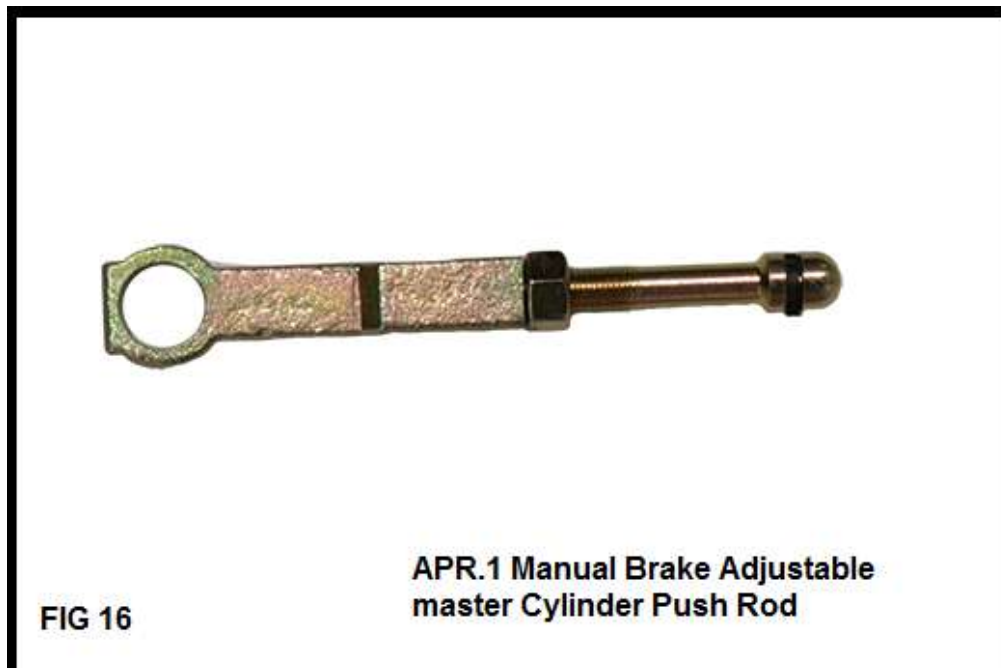
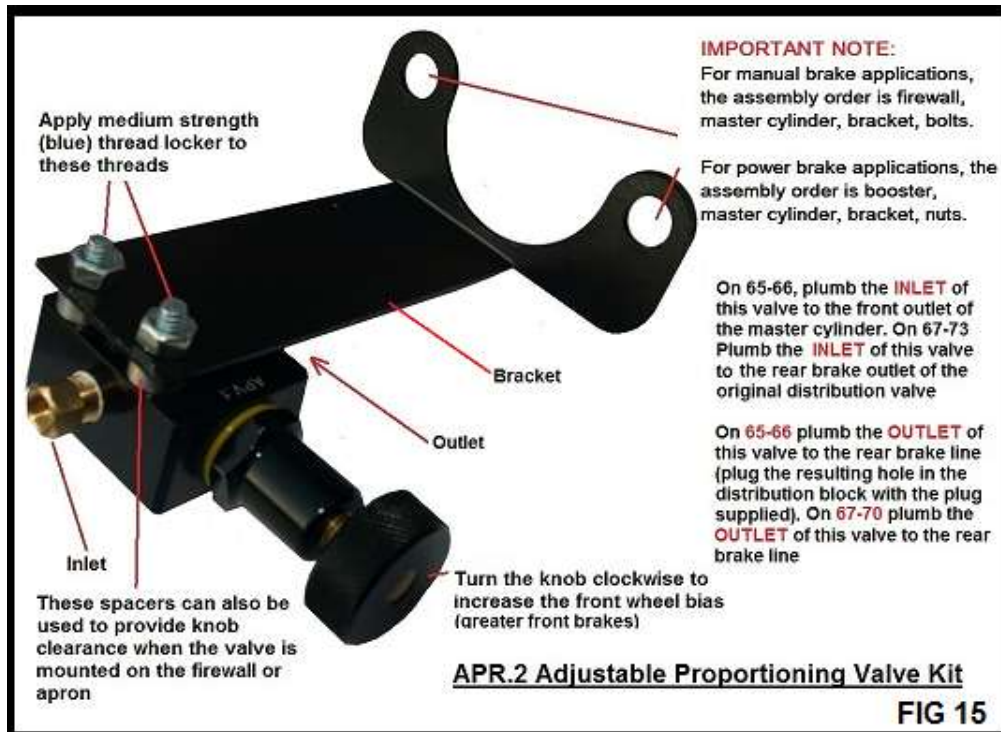

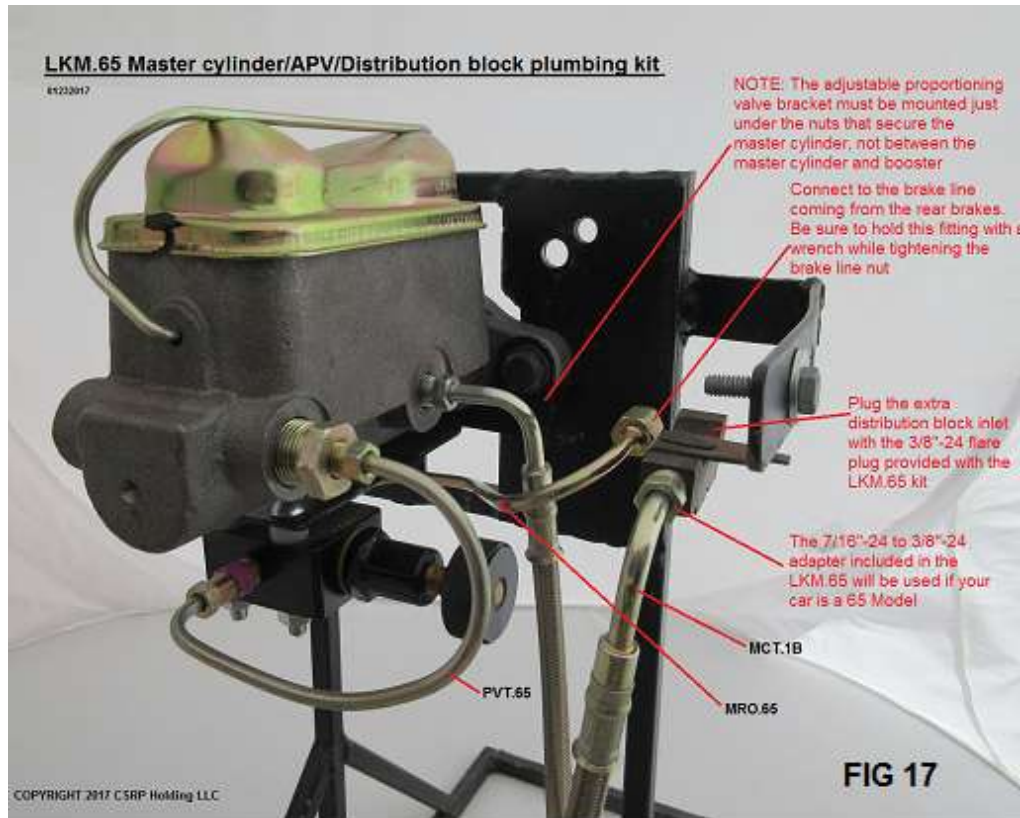

15. The new brake line leading from the rear port of the master cylinder on 65-66 (MCT.1B) has a 7/16"-24 threaded nut at the end that enters the original distribution block. This tube fitting will fit directly into the distribution block outlet on a 66 Mustang, but the 7/16" to 3/8" reduction adapter must be used with 65 Mustang since the 65 has a 3/8"-24 inlet.

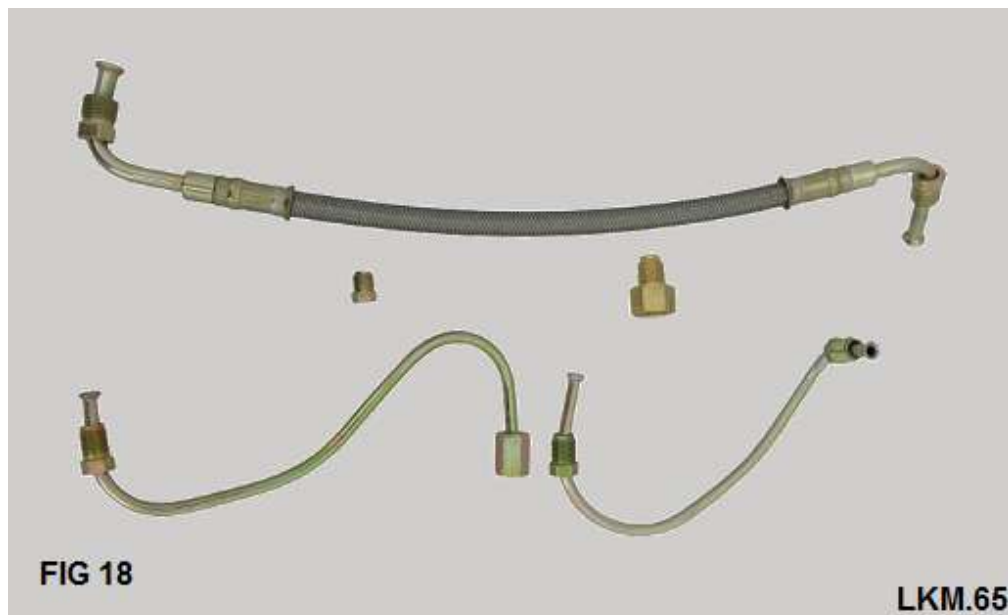

#### F. Bleed the brakes

1. Follow the instructions included with the master cylinder or bleeding aid to bleed the brakes.
2. The task of brake bleeding is made easier if a pressure bleeder is used. The use of speed bleeder screws also makes the task easier. We do not recommend the vacuum bleeding method.
3. The brake pedal should be firm and high when the brakes are properly bled.
4. Remember that there should be at least ½” of slop (1/2” of at rest free play between the bumper at the top of pedal and the pedal bracket).
5. A spongy feel at the pedal is indicative of the failure to bleed all of the air out of the system or the calipers being installed on the wrong sides.



#### G. Front wheel alignment and steering issues

1. Remount the wheels.
2. Remove any jack stands or jacks.
3. Place the car on level ground.
4. Center the steering wheel.
5. Adjust the tie rod sleeves to align the front wheels straight forward.
6. You may stretch a line parallel to the rear and front wheel. It should be possible to roughly set the Toe at 0 degree; that is, the wheels tracking straight forward.
7. Tighten the tie rod sleeve bolts.
8. Roughly adjust the caster and camber to 0 degrees.
9. The camber and caster are likely to be way out of specification. The pads and rotor need “bedding-in” before the brakes will work well.

10. Trailering to an alignment shop is recommended. **Be very careful** if you chose to drive the car to the alignment shop.
11. Have the front end aligned to specifications for toe (1/8" toe in), camber (0.0 to - 0.5 degree), and caster (+2.5 degree).
12. Remember to re-torque the sleeve bolts to 40-45 ft-lb upon returning from the alignment shop.

#### H. Setting the adjustable proportioning valve APV

1. The mechanical installation must be complete.
2. Turn the APV knob fully counter clockwise.
3. Find a level isolated location with normal road surface. A parking lot would be ideal. Ignore the common advice to use a wet or gravel surface.
4. Perform a series of normal stops, like at a stop sign.
5. Turn the APV's knob 1-2 turns clockwise in between each stop.
6. Repeat this process until the stop terminates in a little front end dive. This indicates that the front end has commenced braking first.
7. Some fine tuning may be indicated.

#### I. Pad and rotor bedding-in.

1. Find a level isolated location with normal road surface. A large parking lot would be ideal.
2. Accelerate car to approximately 25 mph.
3. Apply brakes using light to moderate effort to reduce speed to approximately 5 mph (DO NOT stop, if possible).
4. Repeat this process at least 10 times allowing about 1/3 mile between cycles to cool the pads.
5. Avoid hard braking for the first 25 miles.

**The brake SWAP is complete. Carefully inspect all of the work and have a qualified mechanic inspect the work prior to operating the vehicle.**

#### IV. CSRP BRAKE SWAP FAQ

Q. Does the kit come with a dual reservoir master cylinder?

A. Yes, the kit comes with the proper dual reservoir master cylinder. Specify manual or power brakes when ordering. All applications come with an adjustable push rod.

Q. Will I be required to bend and fabricate brake lines for the master cylinder?

A. All CSRP kits come with a full under hood plumbing upgrade kit that includes a combination of braided stainless steel brake lines and steel hard lines that will make it easy to plumbing the master cylinder, proportioning valve and distribution block.

Q. What size are the rotors?

A. The slotted rotors supplied with the kit are 11.2" diameter 5 lug type.

Q. Can I use the outer tie rod ends from my car with the kit?

A. Replacement outer tie rods are included. Reuse the inner tie rod arms.

Q. Do I need to adapt my hard brake lines?

A. The under the fender brake line will need to be modified on the SWAP.2 kits. SWAP.3 and 4 kits do not generally require brake line modification.

Q. What does the kit include?

A. The kit has all NEW parts including caliper brackets, splash shields, an adjustable proportioning valve, performance 11.2" SLOTTED rotors, corrosion protection coated calipers, semi-metallic pads, braided stainless steel brake hoses and new hose mounting brackets and hardware, dual reservoir master cylinder, an adjustable push rod, a complete under hood plumbing kit including braided stainless steel brake lines, bearings and seals, wheel hardware, caliper hardware, grade 8 attachment, blue and red thread locker, high temperature disc brake wheel bearing grease, and our renown installation guide via download. You need only bolt the kit, bleed the system, mount and align the wheels, adjust the proportioning valve, and the installation is complete.

Q. My car has power steering. Will the kit work?

A. Yes, a kit configuration is available for cars with power steering.

Q. My 65-66 Mustang has power brakes (or I want power brakes). Will the car's booster and master cylinder work with the SWAP kit, or will the master cylinder provided with the kit fit on my car's booster?

A. No, the original booster/bracket system used on 65-66 Mustangs is not compatible for use with a dual reservoir master cylinder. There is not enough space between this booster's face and the shock tower to mount one. This is because Ford located the mechanical clutch linkage in a place that interferes with the direct mounting of the booster to the firewall. In order to accommodate both manual and automatic transmission applications with one assembly type, a standoff bracket is employed. This bracket places the booster about 3" away

from the firewall. In this position, it will not mechanically interfere with the operation of the clutch linkage. This works fine with the single reservoir master cylinder which is standard to the model, but will not allow the mounting of the dual reservoir master cylinder necessary for a safe modern brake system.

In any case, the original booster/bracket must be removed. This presents the kit installer with a couple of options. For automatic transmission equipped 65-66 Mustang, CSRP offers a compatible MC/booster/ bracket system that will allow the use of the original pedal. One could also install the kit in manual brake mode. When purchasing the SWAP kit for these cars, the installer must specify a manual or a power brake kit. CSRP only offers power assist upgraded kits for Mustang and Cougar.

On a manual transmission car with original power brakes, the installer must still remove the original booster/bracket, but has fewer practical options for power brakes. CSRP offers a power brake upgrade for this application only if the clutch linkage has been replaced with a cable or hydraulic type that eliminates the interference. Otherwise, the user must install the system as manual brakes or find other options.

Q. My 67-69 Mustang has power brakes (or I want power brakes). Will the master cylinder provided work with the SWAP kit?

A. A kit configured for 67-73 can be provided with a power type master cylinder, proper under hood plumbing kit, and no booster at a minimal extra cost when specified. This master cylinder will work with all existing original equipment boosters present on 67-73 cars. Those users wishing to upgrade their manual brakes from manual to power assist brakes can purchase our power brake assist upgrade kit for 67-70 cars. This upgrade kit will fit all 67-70 Mustang, regardless of transmission or engine type. We do not offer power brake upgrades for 71-73 cars, or for other model cars aside from Mustang and Cougar.

Q. Will the SWAP kit give me bumpsteer? What is bumpsteer?

A. No, the SWAP kit installation does not affect the steering or suspension geometry.

Bumpsteer is the change in steering output that occurs without driver input when the suspension moves. Basically, the wheels turn a little in response to going over bumps. This is a result of the fact that the radius of movement for the tie rods and the ball joints are different. Large deflections of the suspension cause different rates of movement of the control arms vs the tie rods causing a small steering input. This affect is most noticeable, if at all, in performance situations.

All Mustangs and many other 60's and 70's cars are based on the Falcon chassis that Ford developed in the early 60's. The suspension and steering gear for all of

these cars are very similar. The suspension mounting configuration for the class, including most years of Falcon, Comet, Mustang, Cougar, Fairlane, Torino, Montego, Maverick, Granada, and Monarch remains the same from 63-80. There were basically two steering geometries during the period. The 64-66 Mustang and 63-65 Falcon models have a slightly different geometry than the later models. The later models have identical geometry. CSRP makes 2 series of spindles, so the spindles included in CSRP kits have correct steering and suspension geometries for the year model it is configured for.

It is generally recognized the Falcon class chassis had poor suspension geometry, especially the early applications. It is generally agreed that making major modifications to the suspension, like using lowering coil springs, or cutting coil springs, or excessive lowering of the control arms, can exacerbate the inherent poor steering dynamics of the early Mustang (Falcon chassis).

Q. Can I use my original wheels with the swap?

A. SWAP.2, SWAP.3, and SWAP.4 kits require aftermarket 15" wheels with the OE 5 X 4.5" mounting pattern.

Q. Will the swap work with my 6 cylinder car, and will I need to change the steering gear?

A. One may install the kit if the 65-66 6 cylinder car steering knuckles are replaced with the spindles included with the kit along with replacement of the steering linkage with V8 model type. SWAP.2, SWAP.3, and SWAP.4 kits include year model correct V8 type disc brake specific spindles.

Q. Can I keep my 4 lug wheels with the swap?

A. CSRP offers a 4 lug version of the SWAP.2 kit. It requires aftermarket 15" or larger wheels with OE 4 X 4.5" lug pattern.

Q. How long does it take to do the SWAP?

A. The removal of the old parts and installation of the new ones can easily be done in one weekend.

Q. What does a proportioning valve do?

A. A proportioning valve is a vital component of a disc brake system. It is a metering valve that controls the flow of brake fluid to the rear wheel cylinders. It functions to delay the full implementation of the rear brakes. Without the valve, the rear brakes would apply prematurely. An adjustable proportioning valve is the standard one included with the kit. It has an adjustment knob that functions much like a water faucet except that the flow of fluid is never stopped, just restricted.

This valve is simple to plumb, but requires that the installer tune it by trial and error to give the desired rear braking performance (see installation procedure).

Q. Will I need to buy anything else?

A. All parts are included. The cars existing spindles, distribution block, and terminal brake lines are reused. If you chose to replace the brake lines, only the two front terminal lines and the rear terminal line are needed. Drum or disc type are the same with these three lines.

Q. Does the SWAP kit include instructions?

A. The kit includes internet access to the installation guide. This guide goes through the history of the swap, and includes a complete installation guide.

Q. Is the conversion safe?

A. The system is based on an original Ford OEM design. The components are the best available. The installer must be reasonably proficient in mechanics.  
**Brakes are a seriously necessary component of the safety system of your car. Have the new system inspected by a qualified mechanic before driving the car.**

**CSRP will not accept the liability that the owner assumes when purchasing, installing, or using the SWAP.**

## V. LEGAL NOTICE

This document is only a guide. It in no way represents the ultimate authority on the subject presented. The user must exercise good judgment in relying on its content. It is incumbent upon the user to verify the guidance contained within. The seller of these parts and the authors of this guide provide the service of compiling parts that are generally recognized, when properly assembled, to provide a safe and effective front disc brake substitute for the antiquated drum brakes originally present on certain classic Fords from the 60's and 70's. The buyer must determine if is appropriate or prudent to undertake this front disc brake conversion using this kit and guide. The SWAP should only be undertaken by those who are competent in automotive brake system mechanics. The completed system must be installed or inspected by a certified mechanic, and any necessary adjustments made. The purchaser of the parts assumes all liability associated with their use. The seller does not accept liability associated with the use of these parts. The parts are warranted to be free of manufacturing defects for a period of 1 year from the time of purchase. This limited warranty is applied to replacement of the defective part(s) only. The warranty does not apply to any labor associated with installation of the part(s). Please see our terms of



purchase located at our website [www.discbrakeswap.com](http://www.discbrakeswap.com). The provisions contained there apply to this install and the parts herein.

Thank you for purchasing the CSRP front disc brake conversion kit. Good luck and good motoring.